

# Kapitel 10

Drahtspann- Drahtschneidezangen  
/ Bolzenschneider / Krampon- /  
Extraktions- / Drahtfass- /  
Drahtbiegezangen / Schränkhebel

InstruMed AG

## DRAHTSPANNZANGEN



Mayo-Haberiszer

15cm  
20015

18cm  
20018

20cm  
20020

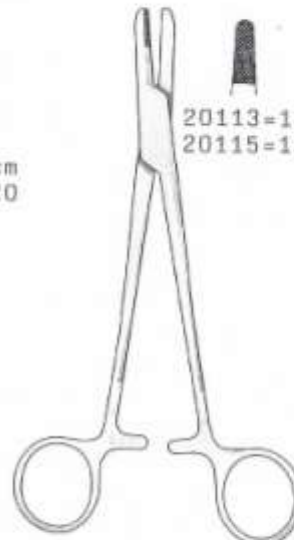

Mayo-Haberiszer

20113=13cm 18cm  
20115=15cm 20118

20cm  
20120



Berry

20218=18cm  
20220=20cm  
20222=22cm

## DRAHTSCHNEIDEZANGEN



16cm  
Diamant  
31016

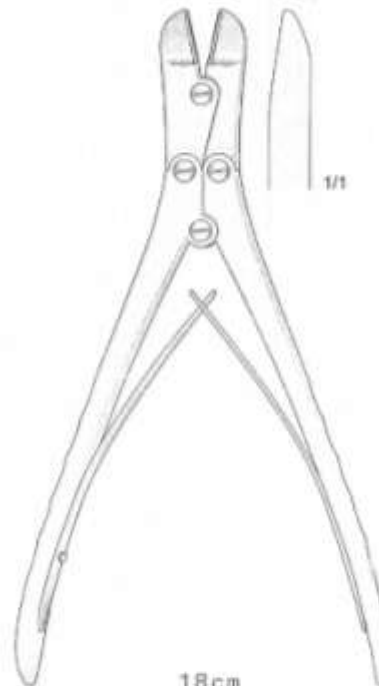

18cm  
07004/18

## HARTMETALL DRAHTSCHNEIDEZANGEN



19cm  
07004/19HM



22cm  
07005/22HM

## HARTMETALL DRAHTSCHNEIDEZANGEN



18 cm  
31218

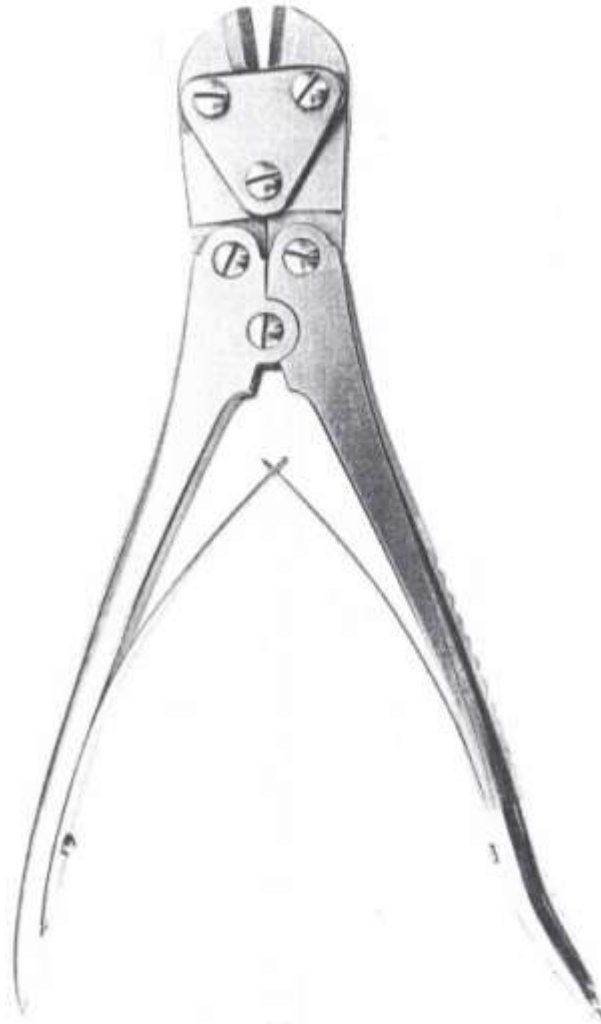

23 cm  
16999

## GEOMED GOLD-CUT HERCULES® Drahtkneifzange



OL 605-23 23 cm / 9"

- über 40% Kraftersparnis
- für Bohrdrähte bis **max. ø 3 mm**
- auswechselbare Hartmetallschneiden
- auswechselbare Gummibacken
- komplett sterilisierbar
- patentiert für GEOMED® Medizin-Technik

### GEOMED GOLD-CUT HERCULES® Wire Cutter

- *over 40% less power required*
- *for drill-wires of **max. ø 3 mm***
- *exchangeable TC-blades*
- *exchangeable rubber jaws*
- *fully sterilisable*
- *patented for GEOMED® Medizin-Technik*

### GEOMED GOLD-CUT HERCULES® Alicate para alambre

- *reducción de la fuerza manual en más de un 40%*
- *para taladros filiformes de **max. ø 3 mm***
- *placas de tungsteno intercambiables*
- *bocas de goma intercambiables*
- *completamente esterilizable*
- *patentado por GEOMED® Medizin-Technik*

### Ersatzteilsets Spare Part Sets Juegos de recambios

OL 606-01  
OL 606-02



## Die große GEOMED GOLD-CUT HERCULES® Drahtkneifzange

- über 40% Kraftersparnis
- für Bohrdrähte ab 2,0 - 3,5 mm
- auswechselbare Hartmetallschneiden
- auswechselbare Gummibacken
- komplett sterilisierbar
- patentiert für GEOMED® Medizin-Technik

### The big GEOMED GOLD-CUT HERCULES® Wire Cutter

- over 40% less power required
- for drill-wires of 2.0 - 3.5 mm
- exchangeable TC-blades
- exchangeable rubber jaws
- fully sterilisable
- patented for GEOMED® Medizin-Technik

### El grande GEOMED GOLD-CUT HERCULES® Alicata para alambre

- reducción de la fuerza manual en más de un 40%
- para taladros cilíndricos de 2.0 - 3.5 mm
- placas de tungsteno intercambiables
- bocas de goma intercambiables
- completamente esterilizable
- patentado por GEOMED® Medizin-Technik

### Ersatzteilsets Spare Part Sets Juegos de recambios

OL 607-01  
OL 606-02



OL 620-28 28 cm / 11"

## GEOMED GOLD-CUT HERCULES® Drahtkneifzange



**OL 602-18 18 cm / 7"**

für Linkshänder / for left-handers /  
para la mano izquierda



**OL 603-18 18 cm / 7"**

für Rechtshänder / for right-handers /  
para la mano derecha



- über 40% Kraftersparnis
- für Bohrdrähte bis **max. ø 2,2 mm**
- wahlweise für Links- und Rechtshänder
- auswechselbare Hartmetallschneiden
- auswechselbare Gummibacken
- komplett sterilisierbar
- patentiert für GEOMED® Medizin-Technik

### GEOMED GOLD-CUT HERCULES® Wire Cutter

- over 40% less power required
- for drill-wires of **max. ø 2,2 mm**
- alternatively for right- and left-handers
- exchangeable TC blades
- exchangeable rubber jaws
- fully sterilisable
- patented for GEOMED® Medizin-Technik

### GEOMED GOLD-CUT HERCULES® Alicate para alambre

- reducción de la fuerza manual en más de un 40%
- para taladros filiformes de **max. ø 2,2 mm**
- disponible para la mano izquierda y derecha
- placas de tungsteno intercambiables
- bocas de goma intercambiables
- completamente esterilizable
- patentado por GEOMED® Medizin-Technik

### Ersatzteilsets Spare Part Sets Juegos de recambios

OL 604-01  
OL 606-02



## Ersatzteilsets Spare Part Sets Juegos de recambios

---

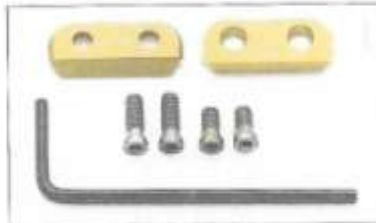

### **OL 604-01**

passend zu / fits to / compatible a OL 602-18 / OL 603-18

1 Paar Hartmetallschneiden / 2 Paar Schrauben /  
1 Inbusschlüssel

*1 pair of TC-blades / 2 pairs of screws / 1 Allen key*

*1 par de placas de tungsteno / 2 pares de tornillos /  
1 llave hexagonal*

### **OL 606-01**

passend zu / fits to / compatible a OL 605-23

1 Paar Hartmetallschneiden / 2 Paar Schrauben /  
1 Inbusschlüssel

*1 pair of TC-blades / 2 pairs of screws / 1 Allen key*

*1 par de placas de tungsteno / 2 pares de tornillos /  
1 llave hexagonal*

### **OL 607-01**

passend zu / fits to / compatible a OL 620-28

1 Paar Hartmetallschneiden / 2 Paar Schrauben /  
1 Inbusschlüssel

*1 pair of TC-blades / 2 pairs of screws / 1 Allen key*

*1 par de placas de tungsteno / 2 pares de tornillos /  
1 llave hexagonal*



### **OL 606-02**

passend zu / fits to / compatible a

**OL 602-18 / OL 603-18 / OL 605-23 / OL 620-28**

1 Paar Gummibacken / 1 Paar Schrauben

*1 pair of rubber jaws / 1 pair of screws*

*1 par de bocas de goma / 1 par de tornillos*

**HARTMETALL  
DRAHTSCHNEIDEZANGEN**



**HARTMETALL  
DRAHTSCHNEIDEZANGEN**

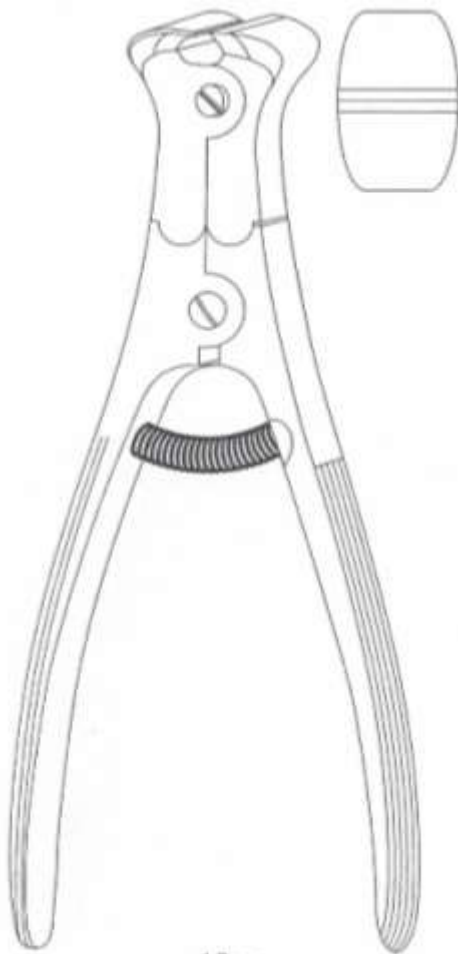

15cm  
Kopfschneider  
32015

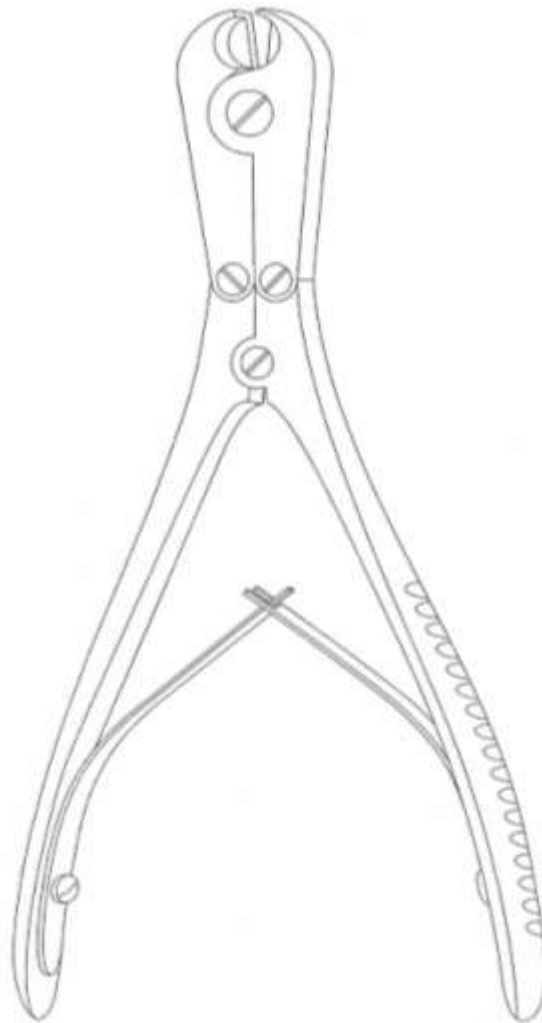

18cm  
Kopf- u. Seitenschneider  
34018

## BOLZENSCHNEIDER



46cm  
16155

Bolzenschneider zum Schneiden  
von Kirschner Drähten, Steinman  
Nägeln und Schrauben bis 6mm

Cutter for cutting of Kirschner wires  
Steinman Pins and Screws up to 6mm  
diam.



56cm  
16156

## BOLZENSCHNEIDER DRAHTSCHNEIDEZANGEN KOPFSCHNEIDER



47 cm  
35047



Ersatzbacken  
35099

Bolzenschneider zum Abzwicken  
von Drähten, Kopfschrauben und  
Nägeln bis 6mm  
Cutter for cutting of wires, head  
screws and pins up to 6mm

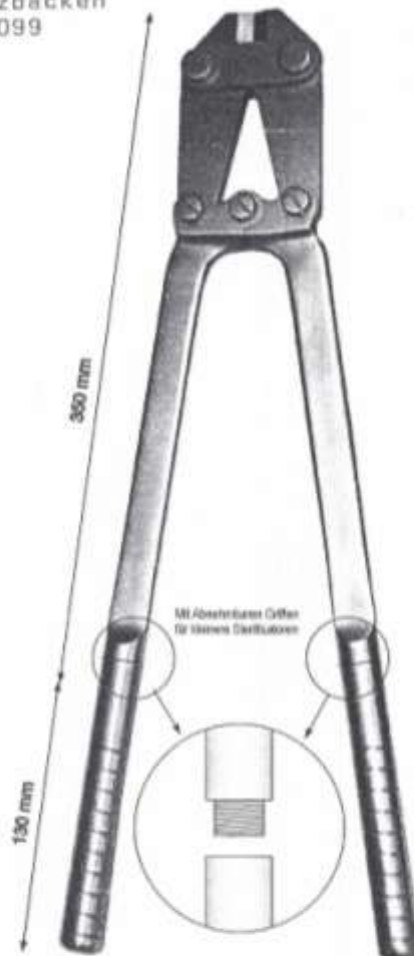

48 cm  
35248

Kopfschneider zum Abzwicken  
von Drähten, Kopfschrauben und  
Nägeln bis 4,5mm  
Head cutter for cutting of wires, head  
screws and pins up to 4,5mm



38 cm  
35248

## UNIVERSAL KRAMPONZANGE

Für harten Draht bis 1mm  
for hard wire 1mm  
Para alambres duros 1mm  
per filo duro 1mm



15cm  
10261



15cm  
10262

## HARTMETALL DRAHTSCHNEIDEZANGEN

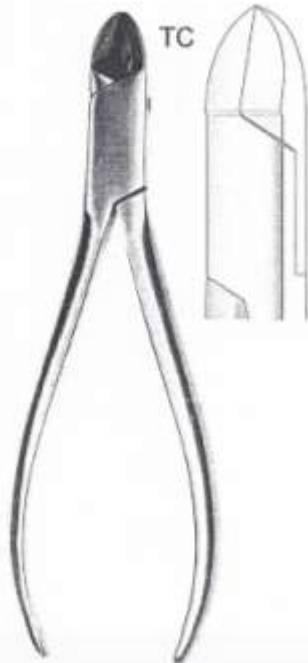

## DRAHTSCHEREN

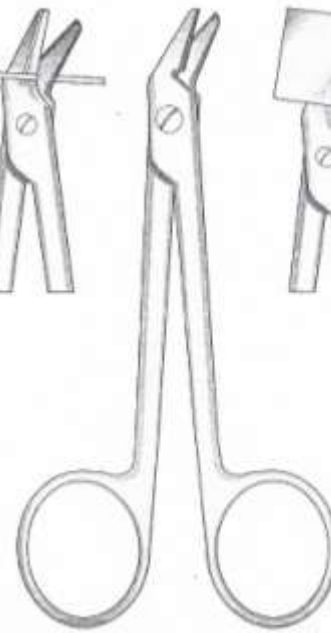
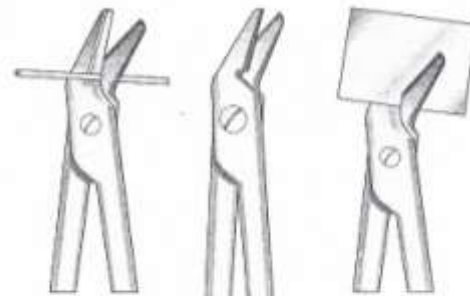

Universal  
12cm  
54712



Smith  
16cm  
39216



Smith  
16cm  
39416

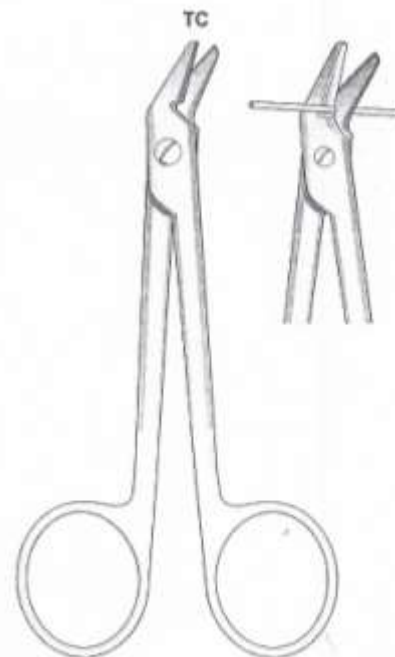

Universal  
12cm  
00528/12HM



## FLACHZANGEN

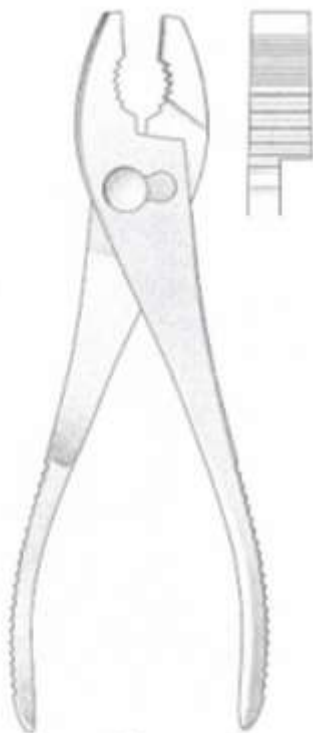

20cm  
26420

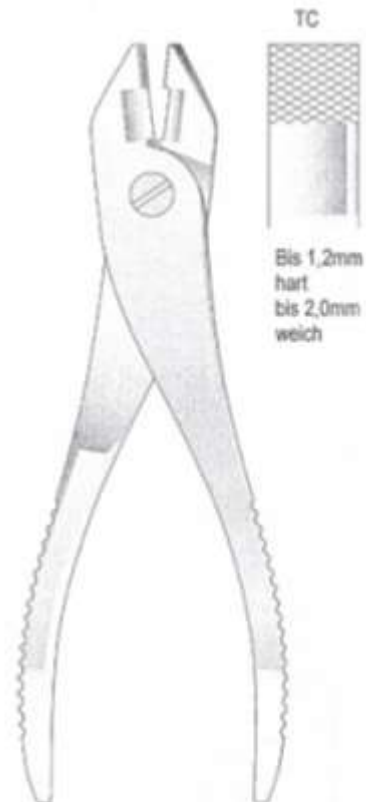

22cm  
26522

TC



Bis 1,2mm  
hart  
bis 2,0mm  
weich

## EXTRAKTIONSZANGEN für Bohrdrähte



17cm



27419  
19cm



13cm  
28013

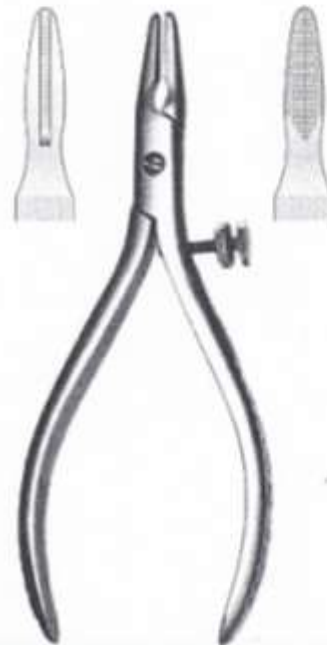

18cm  
28018

## FLACHZANGEN



14cm  
Harburg



26203



26202



26201

Mit Hartmetalleinlage  
with TC inserts



26206



14cm  
26014

## Flachzangen

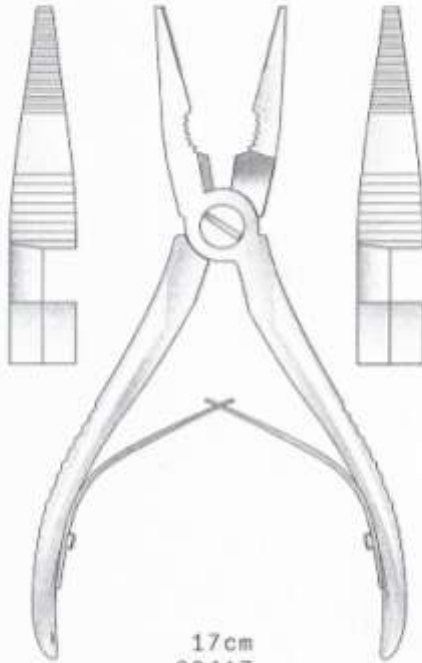

17cm  
22417

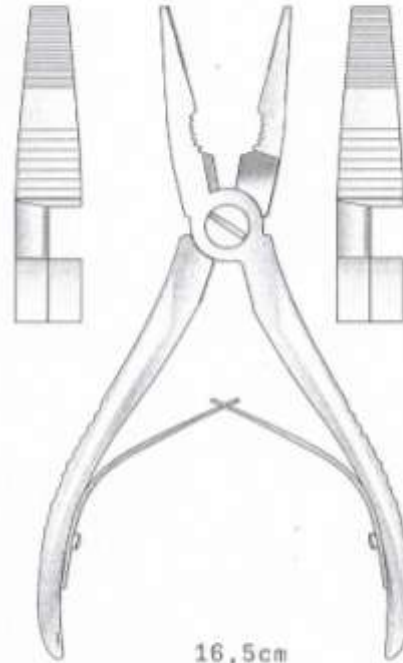

16,5cm  
22516

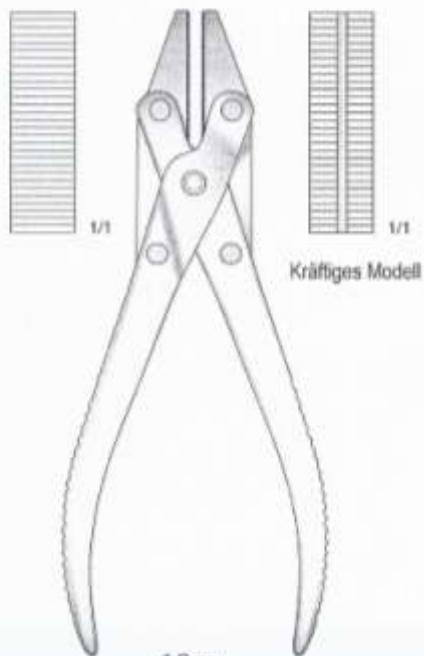

Kräftiges Modell

18cm  
07069



18cm  
07068

## DRAHTFABZANGEN

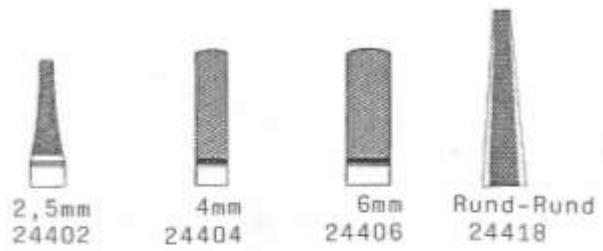
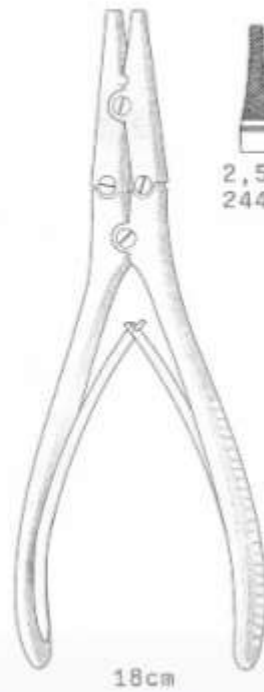
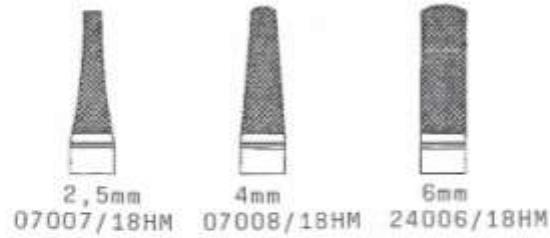
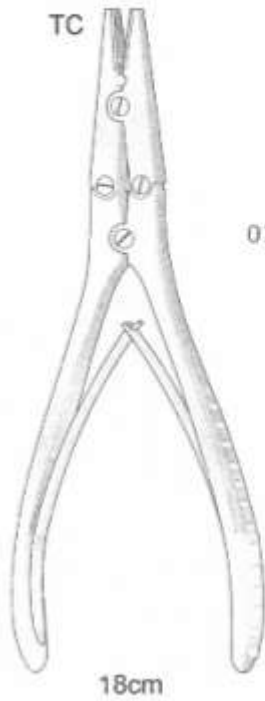

## PATTENBIEGEZANGEN BIEGEAPPARAT

Für Platten bis 1,6mm  
For plates up to 1,6mm

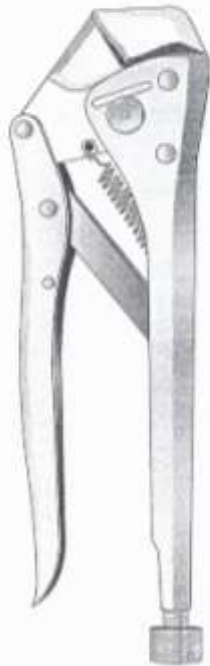

20cm  
60020

Für Platten bis 3mm  
For plates up to 3mm

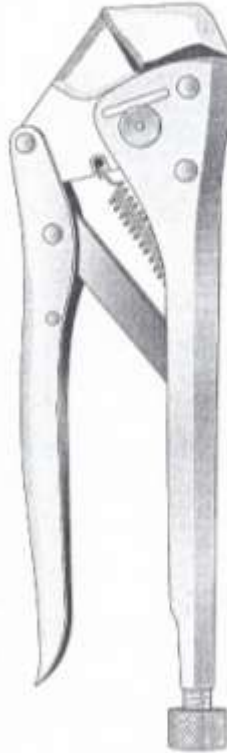

24cm  
60024



Biegeapparat zum Biegen von Knochenplatten  
bis 6mm Dicke. Der untere Backen ist herausnehmbar.  
Komplett aus rostfreiem Material gefertigt

61000

## Schränkheber

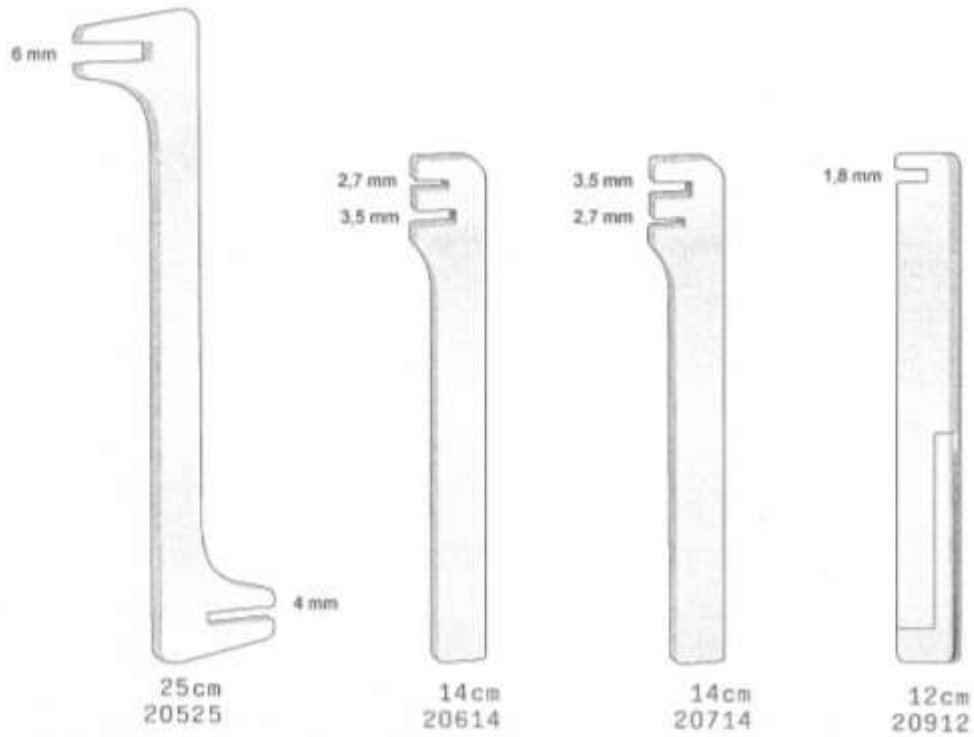



## Universalzange

Maulteil ist über mehrer Rasterstufen verstellbar

- ✓ Vielseitig einsetzbar
- ✓ Robus
- ✓ Sterilisierbar

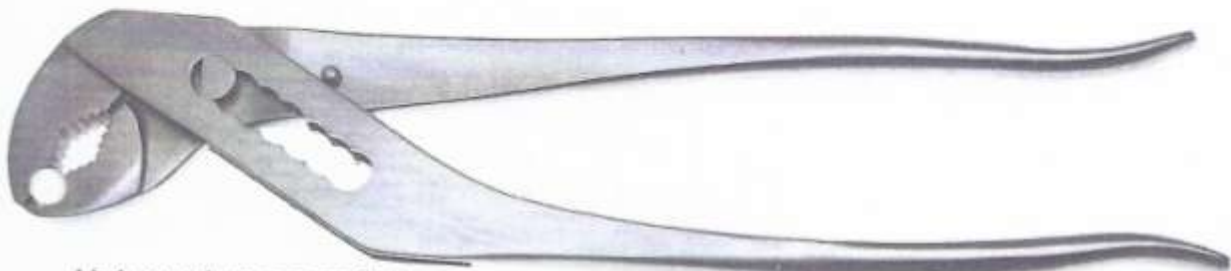

**Universalzange groß \***  
(Wasserpumpenzange)  
255/30 - 30cm

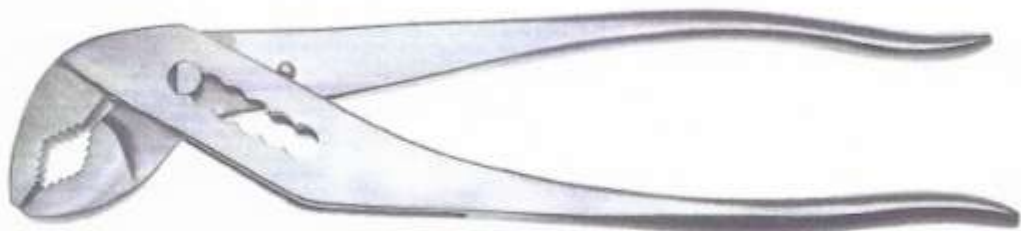

**Multizange mittel \***  
(Wasserpumpenzange)  
255/24 - 24cm

\* Komplet aus gehärtetem Chirurgiestahl



## HANDBOHRFUTTER

ANATOMISCHE FORM

Nur Bohrfutter  
Automatik  
065.85



Handbohrfutter  
Automatik  
komplett  
065.10



*Alle Bohrfutter mit  
Schnellspanverschluss!*

Nur Bohrfutter  
groß  
065.83



Handbohrfutter  
groß komplett  
065.03



Handbohrfutter  
klein komplett  
065.01



Nur Bohrfutter  
klein  
065.81



Handbohrfutter  
T-Griff  
065.99